

SEMBLANCE

MODULAR SYSTEM

PACKAGE 5464-LD

COMPONENT LIST



Component List

15001

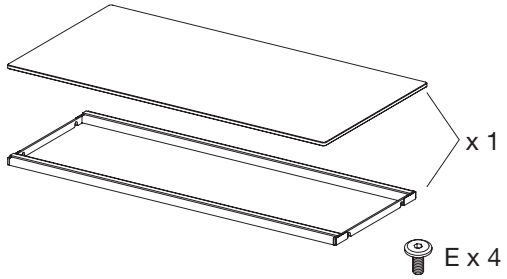

x 7

15023

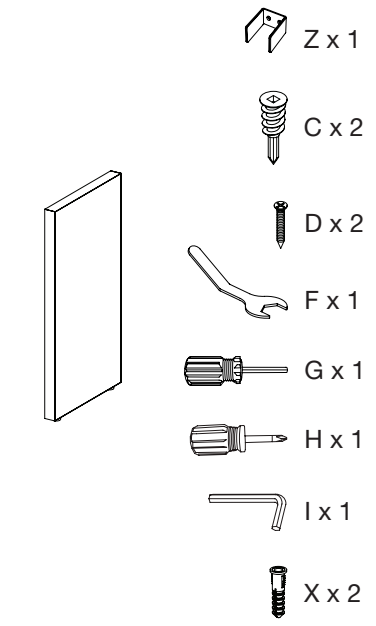

x 2

15011

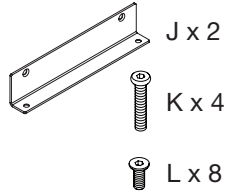
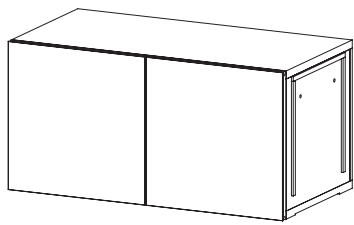

x 1

15021

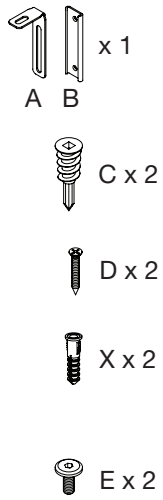
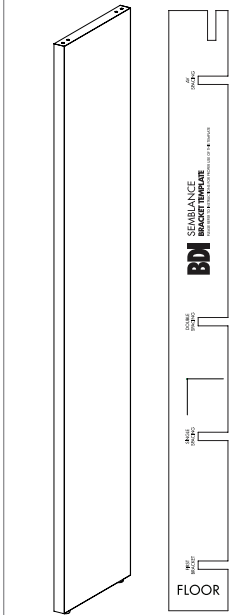

x 1

Tools are included in **15023**

15028

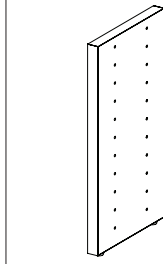

x 1

15031

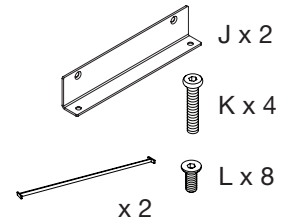
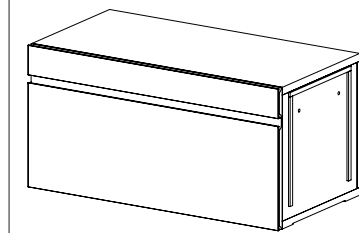

x 2

Sequel Lift Desk 6052 x 1

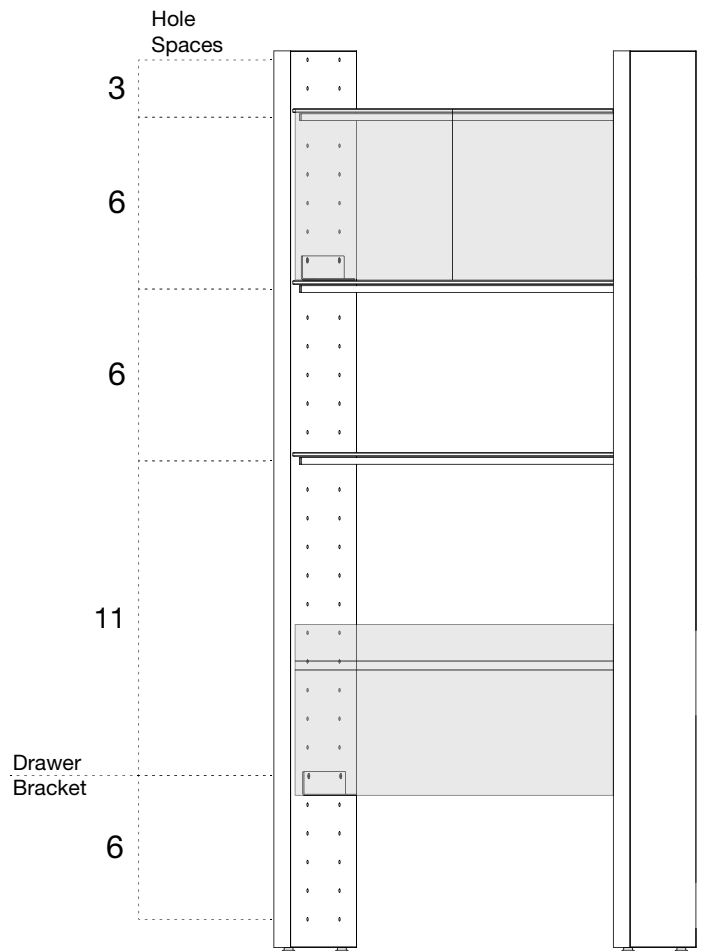
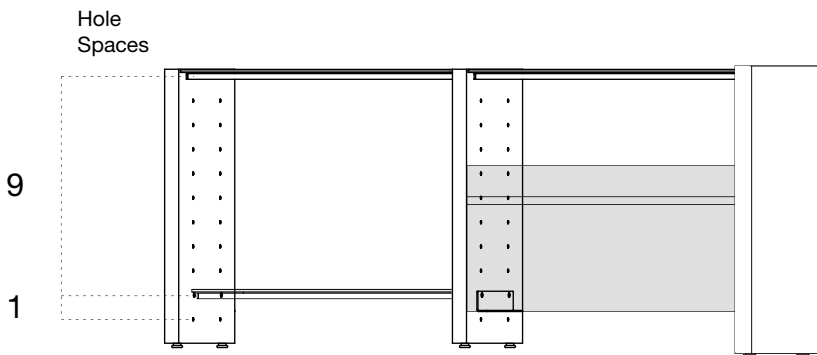

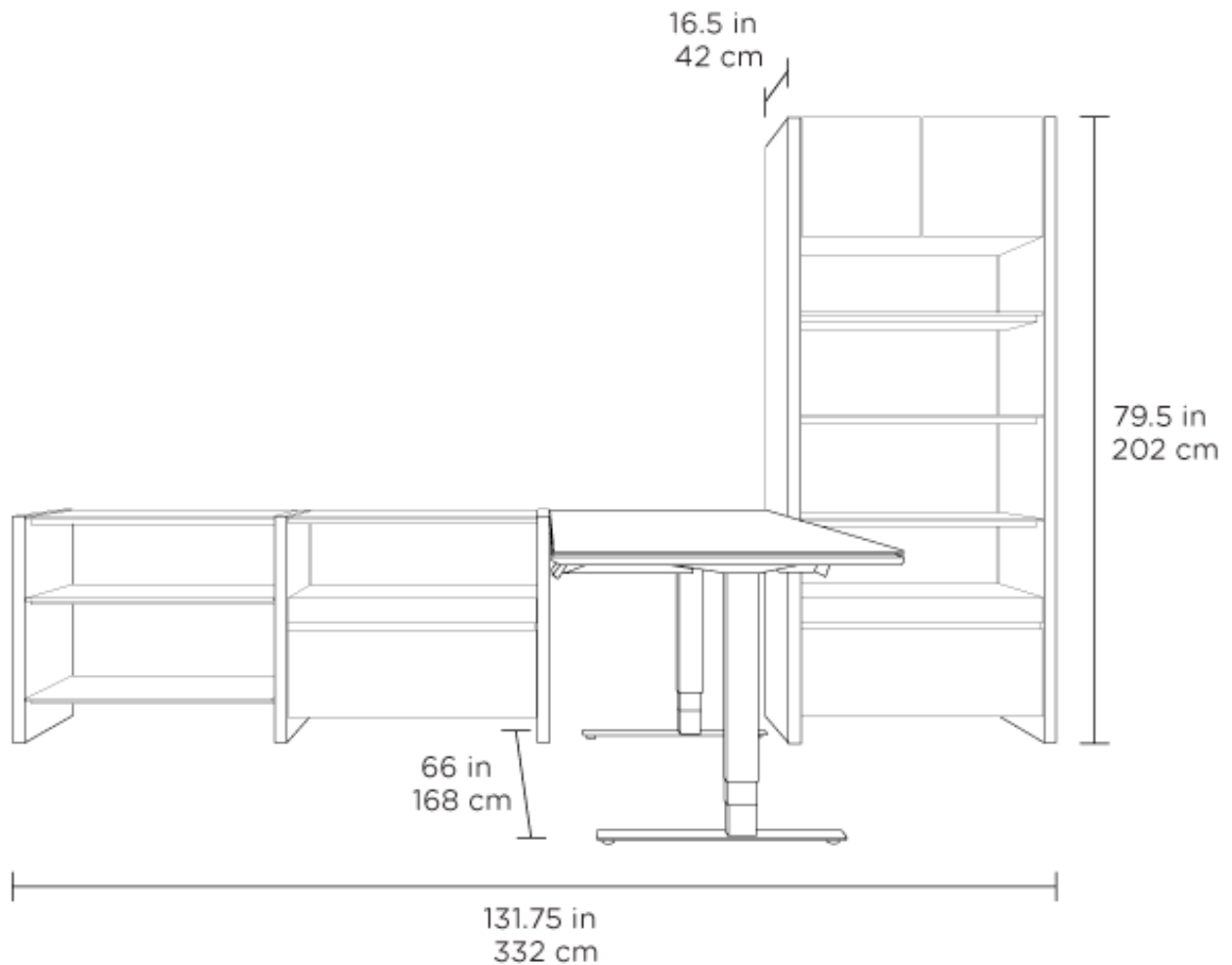

Helpful Tips for Designing your own Semblance Package.

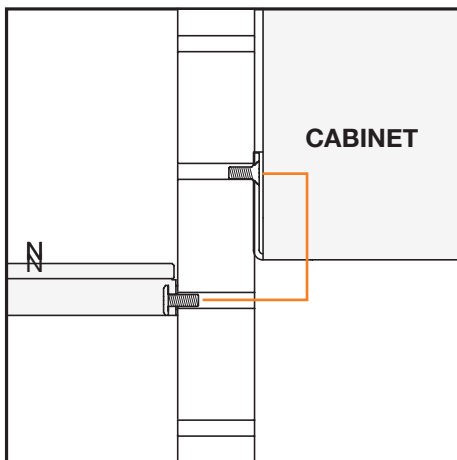

The Cabinet Bracket Screw must be 1 space hole above the Shelf Screw to align Cabinet bottom with the top of a Shelf.

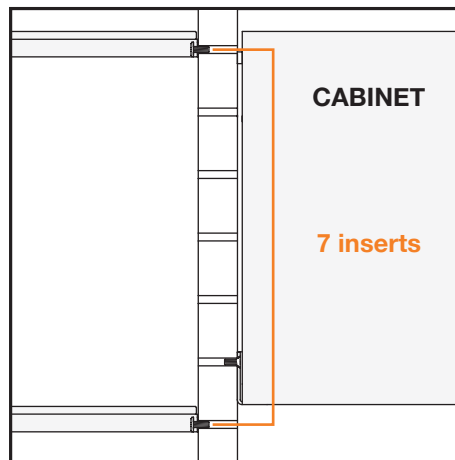

There is a 7 insert spacing pattern to align Shelves with top and bottom of a Cabinet.

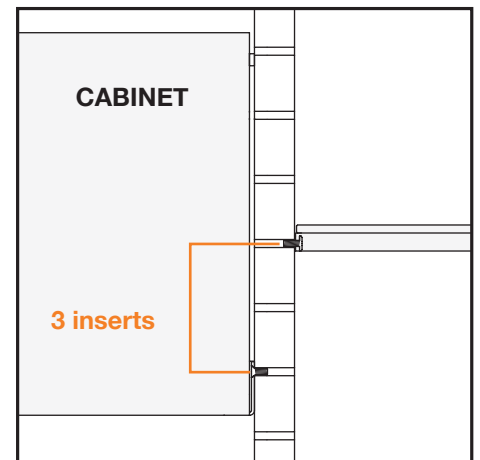

There is a 3 insert spacing pattern, from Cabinet Bracket to Shelf Frame, to align Shelves with middle of a Cabinet.